

## 4-SEC 12" BACKPLATE

DWTBBA504AEFF

FLAT BLACK FRONT & BACK

DWTBBA504AEFG

FLAT BLACK FRONT & WEST COAST GREEN BACK

DWTBBA504AEFY

FLAT BLACK FRONT & FEDERAL YELLOW BACK

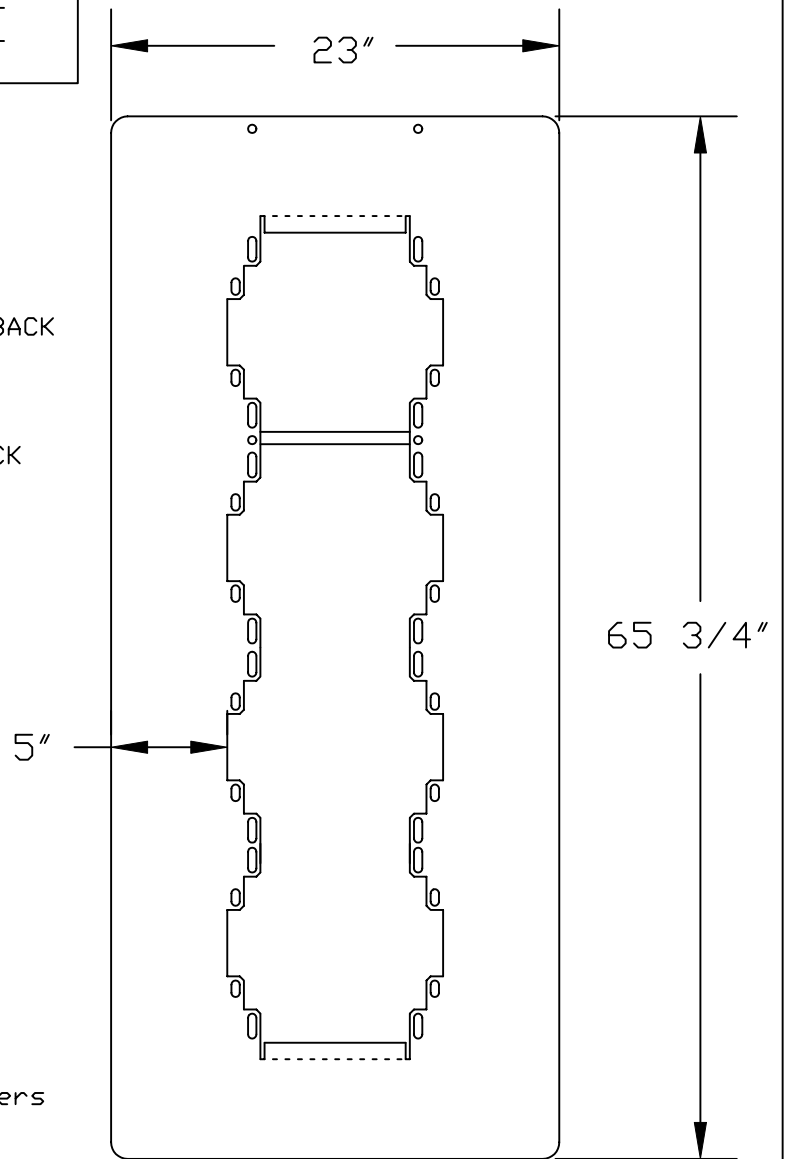

Designed for use with elevator plumbizers  
Remove knock-outs prior to mounting  
Install batten plate after mounting

### FUNCTION:

To outline signal heads on the horizon and reduce the effects of sun phantom

### SPECIFICATIONS:

1. Completely fabricated from 0.063" aluminum sheet alloy (State of Alaska Specifications)
2. Nominal outside dimensions of 5"
3. Powdercoated flat black, additional colors are paint over powder
4. Fabricated with knock-outs, for adapting to elevator plumbizers
5. All mounting hardware stainless steel
6. Comes with 1" batten plate

### OPTIONAL FEATURES:

1. Flat black anodized finish
2. Enamel paint finishes



**WESTERN TRAFFIC SYSTEMS INC.**

909 SE EVERETT MALL WAY #A120  
EVERETT, WA 98208